

ROMA

DIEGO SFERRAZZA



Madia in agglomerato di legno a due ante battenti, 2 cassetti interni, ripiani regolabili in altezza, lavorazione geometrica sulle superfici verticali esterne (ante e spalle), basamento h 10 cm. (stesso colore e finitura del mobile). Le due nicchie a giorno possono essere di colore diverso dal mobile, sono illuminate con sistema a luce led ricaricabile (usb), accensione tramite sensori di movimento (luce regolabile in intensità e calore). Disponibile nella finitura goffrata nei colori a campionario ed in finitura super opaca nei colori in scheda Super Matt.

Il contenitore è consegnato smontato in 3 parti per agevolare le operazioni di consegna.

High container in composite wood with 2 hinged doors, 2 inside drawers, shelves adjustable in height, geometric working on the external vertical surfaces (doors and sides), h.10 cm. base (same colour and finish of the container).

The two open niches can have a different colour than the container, they are illuminated with a rechargeable Led light system (USB), switched on via motions sensors (light adjustable in intensity and heat). Available in embossed finish in all colours of our sample catalogue and in Super Matt finish in the colours of Super Matt colour chart.

The container is delivered disassembled in 3 parts in order to facilitate the delivery operations.

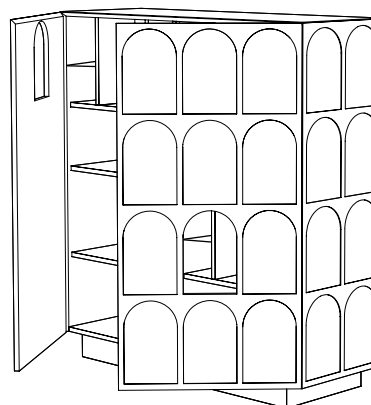
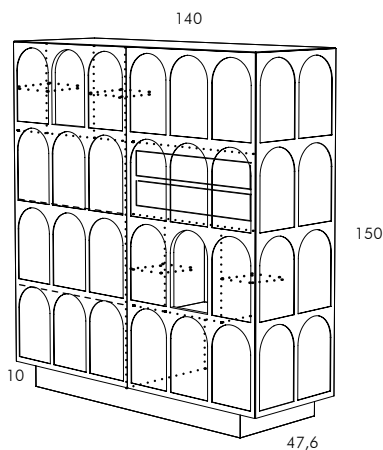
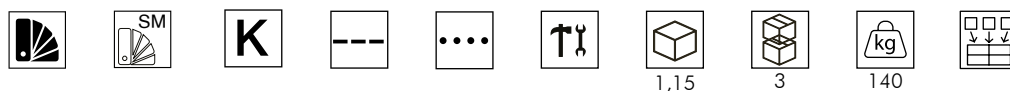

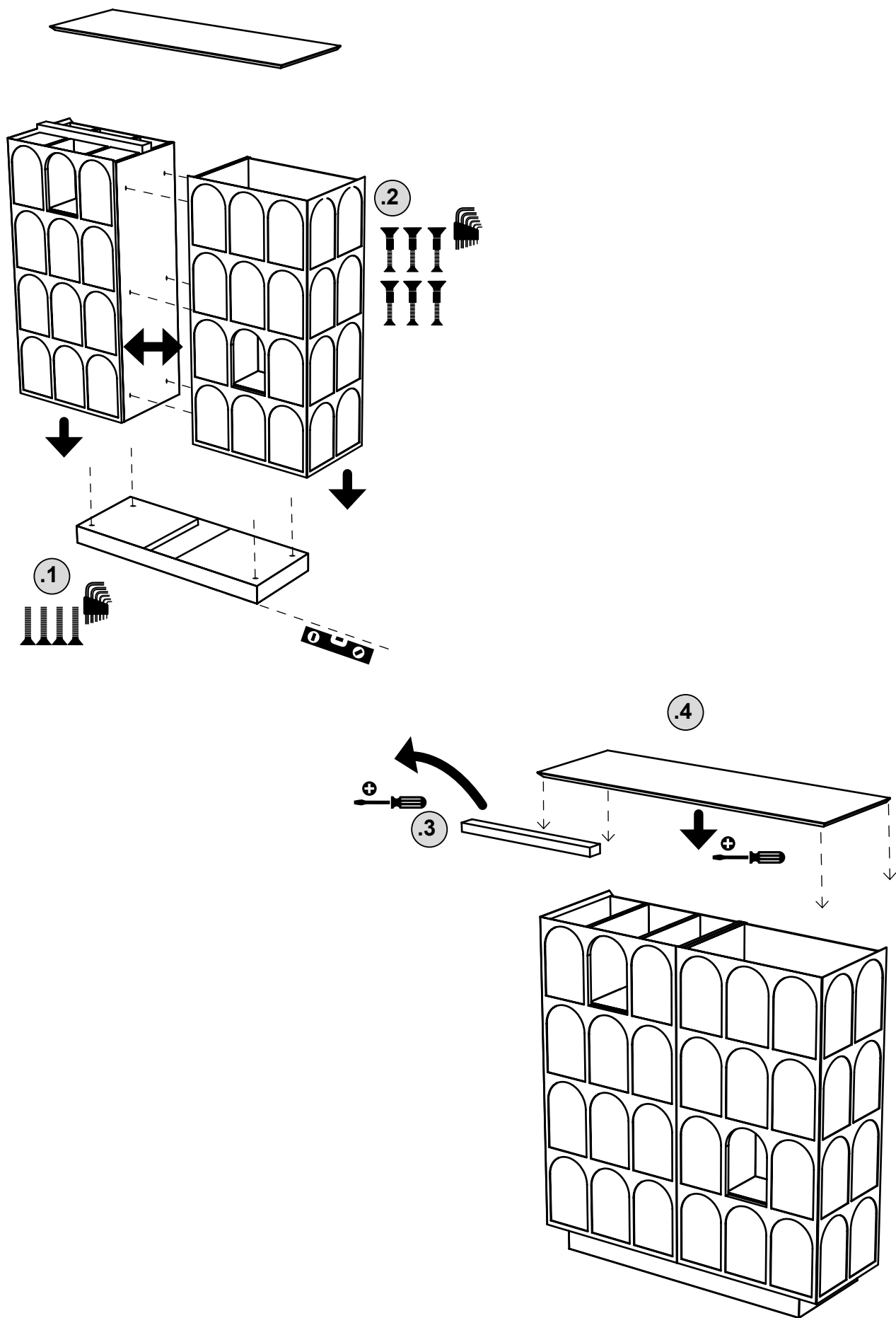

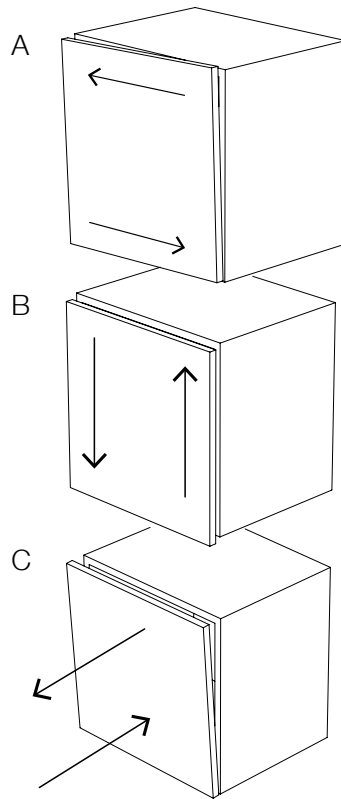
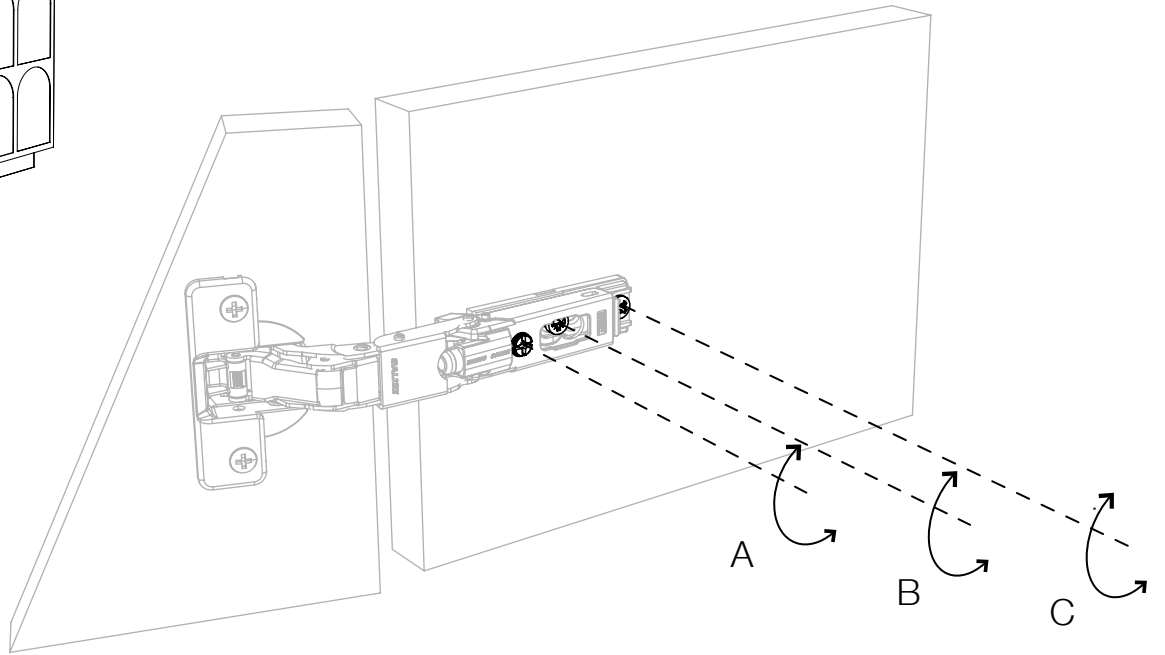
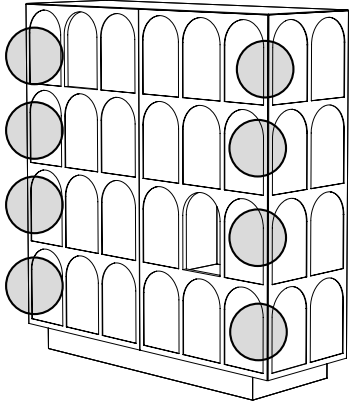



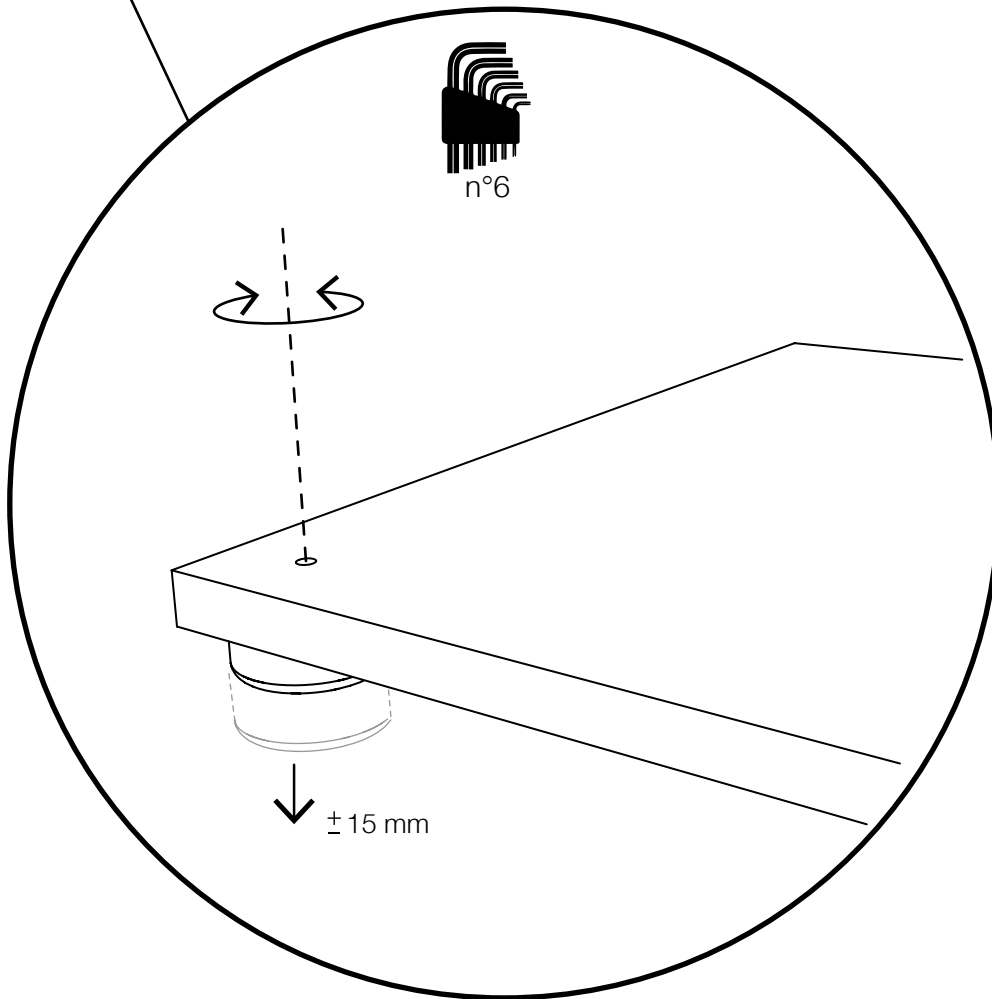
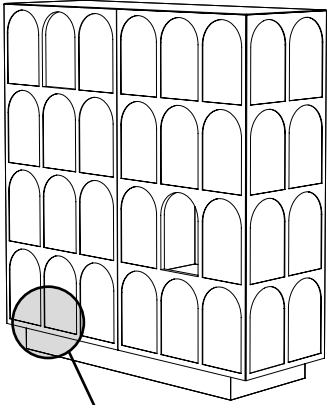









































minottiitalia



minottiitalia

DA TI TE CNI CI TE CH NIC AL DA TA

	LACCATURA GOFFRATA NEI COLORI A CAMPIONARIO EMBOSSED LACQUERING IN ALL COLORS OF OUR SAMPLE CATALOGUE		DOOR APERTURA DESTRA/SINISTRA OPENING RIGHT/LEFT
	LACCATURA SUPER OPACA NEI COLORI - SCHEDE SUPER MATT SUPER MATT FINISH IN THE COLOURS OF SUPER MATT COLOUR CHART CATALOGUE		K RIPIANO IN CRISTALLO EXTRA CHIARO EXTRA-CLEAR CRYSTAL SHELF
	FOGLIA ORO GOLD LEAF		ESSENZA LARICE SPAZZOLATO/FINITURA LACCATO GOFFRATO NEI COLORI A CAMPIONARIO ESSENCE LARCH BRUSHED/EMBOSSED LACQUERING IN ALL COLORS OF OUR SAMPLE CATALOGUE
	FOGLIA ARGENTO SILVER LEAF		TEAK OPACO / MDF NERO MATT TEAK / BLACK MDF
	OTTONE LUCIDO POLISHED BRASS		ESSENZA ZIRICOTE ESSENCE OF ZIRICOTE
	NICHEL LUCIDO POLISHED NICKEL		ESSENZA TEAK ESSENCE OF TEAK
	OTTONE SATINATO SATIN BRASS		FINITURA CEMENTO BIANCO SPATOLATO SPATULATED WHITE CEMENT FINISH
	NICHEL SATINATO SATIN NICKEL		FINITURA CEMENTO GRIGIO SPATOLATO SPATULATED GREY CEMENT FINISH
	INOX INOX		FINITURA CEMENTO ANTRACITE SPATOLATO SPATULATED ANTHRACITE CEMENT FINISH
	METALLO BIANCO GOFFRATO EMBOSSED WHITE METAL		CEMENTO BIANCO WHITE CONCRETE
	METALLO ANTRACITE GOFFRATO EMBOSSED ANTHRACITE METAL		CEMENTO GRIGIO GREY CONCRETE
	METALLO NERO OPACO MATT BLACK METAL		CEMENTO ANTRACITE ANTHRACITE CONCRETE
	METALLO BIANCO OPACO MATT WHITE METAL		LED 5 CANALI: RGB+BAINCO CALDO/FREDDO 3000/6000 K LED 5 CHANNELS: RGB+WARM/COLD WHITE LIGHT 3000/6000 K
	NICHEL NERO LUCIDO POLISHED BLACK NICKEL		LED LUCE BIANCA CALDA 3000 K LED WARM WHITE LIGHT 3000 K
	NICHEL NERO SATINATO SATIN BLACK NICKEL		MODULO DESTRO / SINISTRO UNIT RIGHT / LEFT
	SPECCHIO STANDARD STANDARD MIRROR		FISSAGGIO A PARETE WALL FIXING
	SPECCHIO BRONZATO BRONZE MIRROR		ASSEMBLARE ASSEMBLING
	SPECCHIO FUME' SMOKED MIRROR		RIPIANO SPOSTABILE MOBILE SHELF
	APERTURA VASISTAS/RIBALTA OPENING UP/DOWN		RIPIANO FISSO FIXED SHELF
	VOLUME VOLUME		PESO WEIGHT
	NUMERO DI COLLI NUMBER OF PACKAGES		MOVIMENTAZIONE AGEVOLATA EASY TRANSPORT
	CENTRO STANZA / BIFACCIALE DOUBLE SIDED FOR CENTER ROOM		TESSUTO SEDUTA E SCHIENALE CONTESSINA

A.
D.
&
GRA
PH
ICS

STUDIO14

minottiitalia

ADION S.R.L.
VIALE REPUBBLICA, 140
22060 – CABIATE – COMO
+39 031 769 251
INFO@MINOTTIITALIA.IT
WWW.MINOTTIITALIA.IT