

MILLE  
STUDIO PANG



MIL  
LE

Tavolo in diverse misure, struttura in metallo (completamente smontabile) finitura goffrata.  
Piani disponibili in cristallo satinato retrolaccato.  
Le finiture della struttura in metallo e dei piani sono disponibili nei colori bianco ed antracite.

*Dining table in different sizes, metal structure (completely disassembling) embossed finishing.  
Tops available in lacquered satin crystal glass.  
the finishing of the metal structure and the top finishing are available in white and anthracite.*

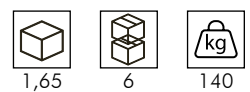
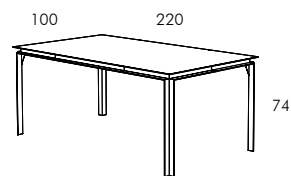
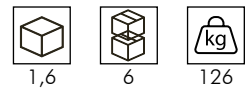
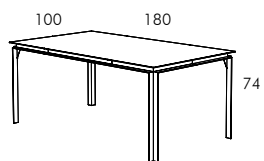
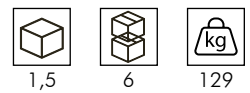
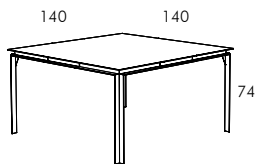
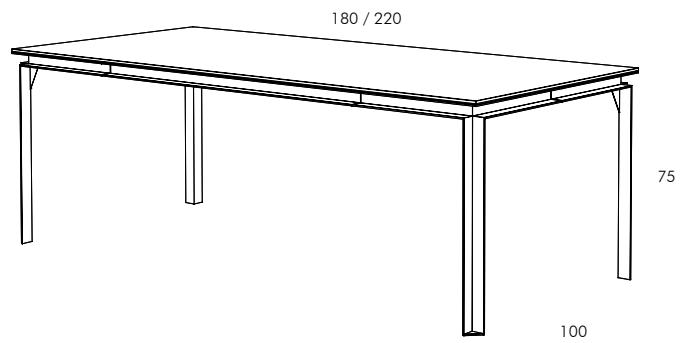
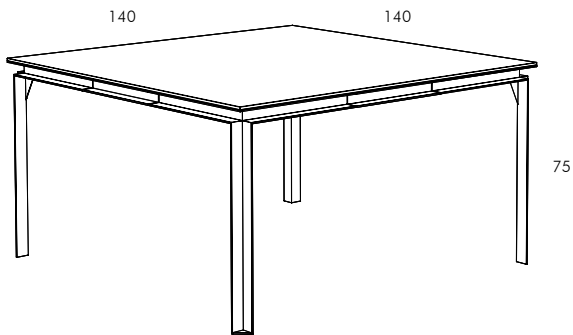

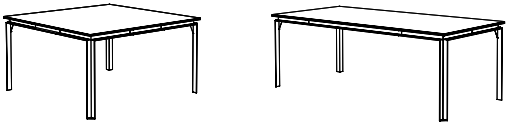

.2

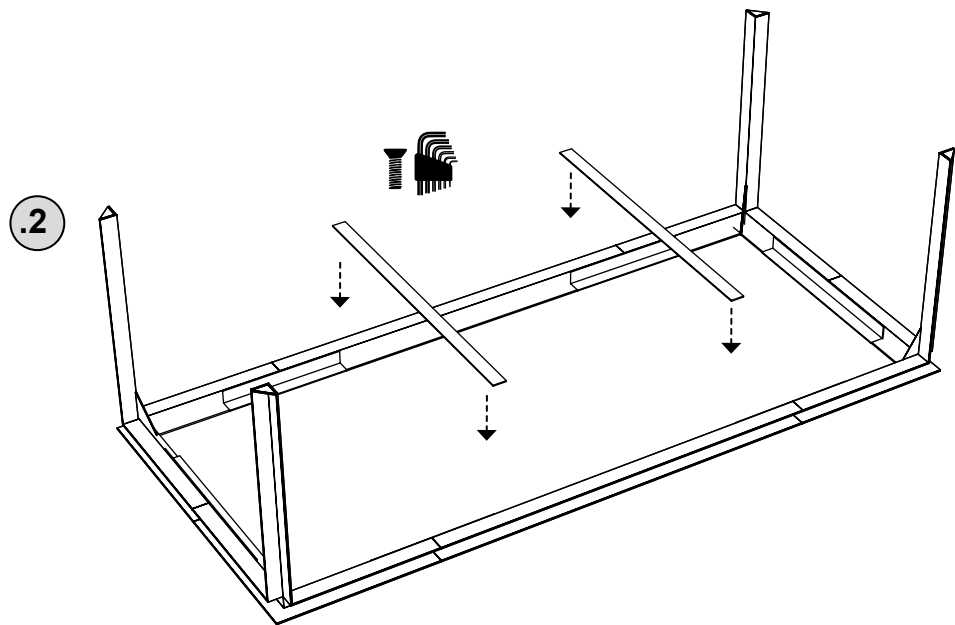
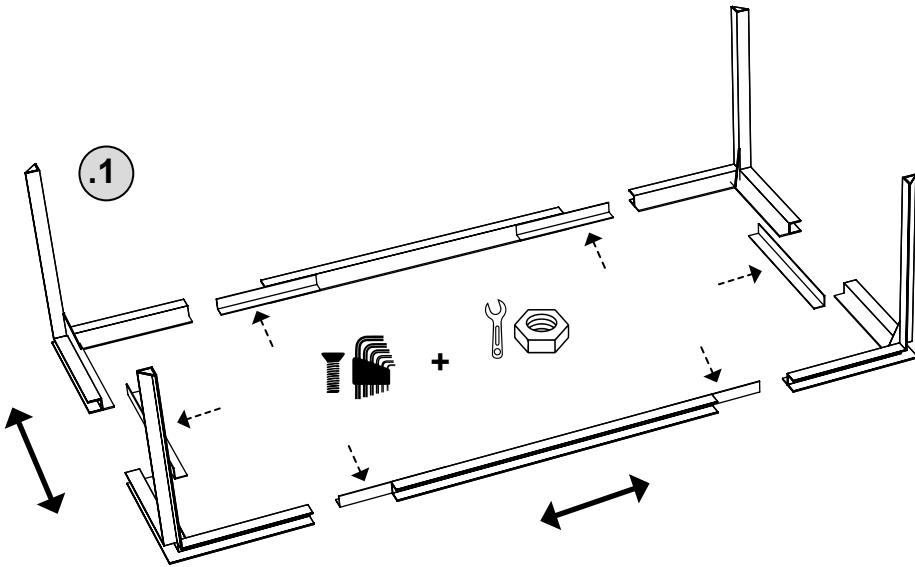

minottiitalia

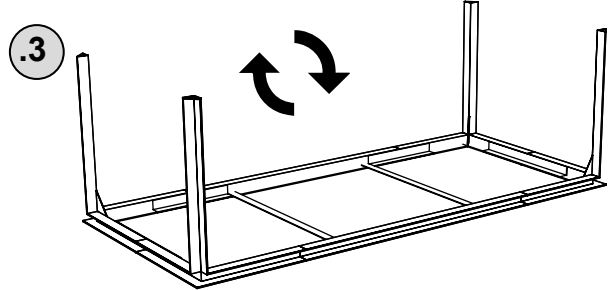
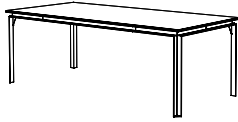
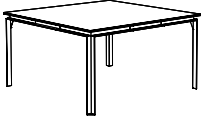



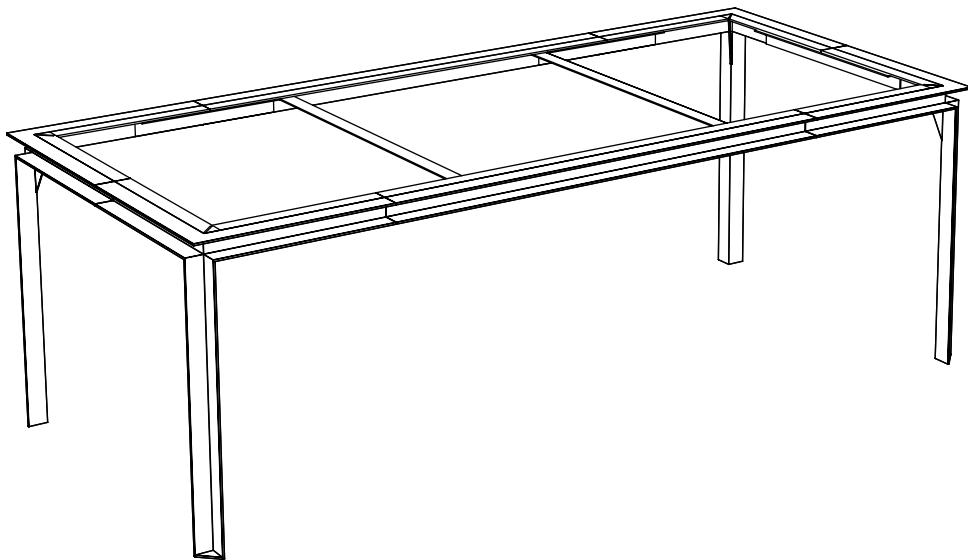









































4



minottiitalia

# DA TI TE CNI CI TE CH NIC AL DA TA

	LACCATURA GOFFRATA NEI COLORI A CAMPIONARIO EMBOSSED LACQUERING IN ALL COLORS OF OUR SAMPLE CATALOGUE		DOOR APERTURA DESTRA/SINISTRA OPENING RIGHT/LEFT
	LACCATURA SUPER OPACA NEI COLORI - SCHEDE SUPER MATT SUPER MATT FINISH IN THE COLOURS OF SUPER MATT COLOUR CHART CATALOGUE		K RIPIANO IN CRISTALLO EXTRA CHIARO EXTRA-CLEAR CRYSTAL SHELF
	FOGLIA ORO GOLD LEAF		ESSENZA LARICE SPAZZOLATO/FINITURA LACCATO GOFFRATO NEI COLORI A CAMPIONARIO ESSENCE LARCH BRUSHED/EMBOSSED LACQUERING IN ALL COLORS OF OUR SAMPLE CATALOGUE
	FOGLIA ARGENTO SILVER LEAF		TEAK OPACO / MDF NERO MATT TEAK / BLACK MDF
	OTTONE LUCIDO POLISHED BRASS		ESSENZA ZIRICOTE ESSENCE OF ZIRICOTE
	NICHEL LUCIDO POLISHED NICKEL		ESSENZA TEAK ESSENCE OF TEAK
	OTTONE SATINATO SATIN BRASS		FINITURA CEMENTO BIANCO SPATOLATO SPATULATED WHITE CEMENT FINISH
	NICHEL SATINATO SATIN NICKEL		FINITURA CEMENTO GRIGIO SPATOLATO SPATULATED GREY CEMENT FINISH
	INOX INOX		FINITURA CEMENTO ANTRACITE SPATOLATO SPATULATED ANTHRACITE CEMENT FINISH
	METALLO BIANCO GOFFRATO EMBOSSED WHITE METAL		CEMENTO BIANCO WHITE CONCRETE
	METALLO ANTRACITE GOFFRATO EMBOSSED ANTHRACITE METAL		CEMENTO GRIGIO GREY CONCRETE
	METALLO NERO OPACO MATT BLACK METAL		CEMENTO ANTRACITE ANTHRACITE CONCRETE
	METALLO BIANCO OPACO MATT WHITE METAL		LED 5 CANALI: RGB+BAINCO CALDO/FREDDO 3000/6000 K LED 5 CHANNELS: RGB+WARM/COLD WHITE LIGHT 3000/6000 K
	NICHEL NERO LUCIDO POLISHED BLACK NICKEL		LED LUCE BIANCA CALDA 3000 K LED WARM WHITE LIGHT 3000 K
	NICHEL NERO SATINATO SATIN BLACK NICKEL		MODULO DESTRO / SINISTRO UNIT RIGHT / LEFT
	SPECCHIO STANDARD STANDARD MIRROR		FISSAGGIO A PARETE WALL FIXING
	SPECCHIO BRONZATO BRONZE MIRROR		ASSEMBLARE ASSEMBLING
	SPECCHIO FUME' SMOKED MIRROR		RIPIANO SPOSTABILE MOBILE SHELF
	APERTURA VASISTAS/RIBALTA OPENING UP/DOWN		RIPIANO FISSO FIXED SHELF
	VOLUME VOLUME		PESO WEIGHT
	NUMERO DI COLLI NUMBER OF PACKAGES		MOVIMENTAZIONE AGEVOLATA EASY TRANSPORT
	CENTRO STANZA / BIFACCIALE DOUBLE SIDED FOR CENTER ROOM		TESSUTO SEDUTA E SCHIENALE CONTESSINA

A.  
D.  
&  
GRA  
PH  
ICS

STUDIO14

minottiitalia

ADION S.R.L.  
VIALE REPUBBLICA, 140  
22060 – CABIATE – COMO  
+39 031 769 251  
INFO@MINOTTIITALIA.IT  
WWW.MINOTTIITALIA.IT